



Message Doll (Cupid)



Cut out the parts, and then carefully follow the assembly instructions.

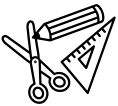

Tools & Materials

- Scissors, utility knife
- Glue stick and wood glue
- Ruler or set square
- Pencil
- Object with pointed tip (dried-up ballpoint pen, stencil pen, etc.)
- Toothpicks
- Tweezers



Tips for Assembly

- Keep track of which part is which by writing each part's number in pencil on the back of the part.
- Use a dried-up ballpoint pen, stencil pen, or other pointed object and a ruler to score along the fold lines. This will create sharper, neater folds.
- Before gluing, fold and crease along the fold lines and add curves where needed.
- Use a toothpick when applying glue. Thinly applied glue gives a neater finish.
- Use tweezers when picking up and attaching small parts.



















Caution

- This paper craft uses scissors, utility knives, glue, and other items and materials which may be dangerous to children. Keep these items and materials out of reach of children while you work.
- Take care not to injure yourself when using scissors, utility knives, and other sharp or pointed objects.



Symbols and Notation

	Pattern		Apply glue (red arrow)
	Assembly instructions		Insert (blue arrow) (Do not apply glue)
(1), (2), (3)...	Part numbers		Add curves
	Mountain fold line (dotted line)		Dots on glue tabs show where and how to glue parts together.
	Valley fold line (dotted & dashed line)		Glue tab (red dot) Glue one part to another part
	Cut line (solid line)		Glue tab (green dot) Glue one place to another on the same part
	Partial cut line (solid red line)		Glue tab (blue dot) Glue one part to the reverse of another part
	Cut-out area		Glue tab (yellow dot) Glue the reverse of two parts together



1

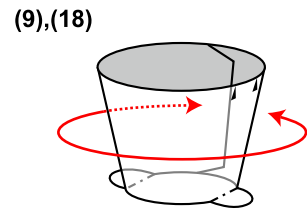
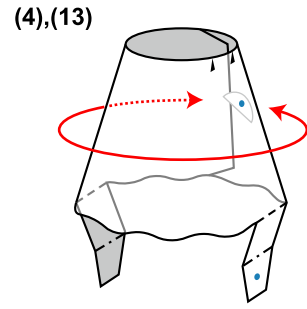
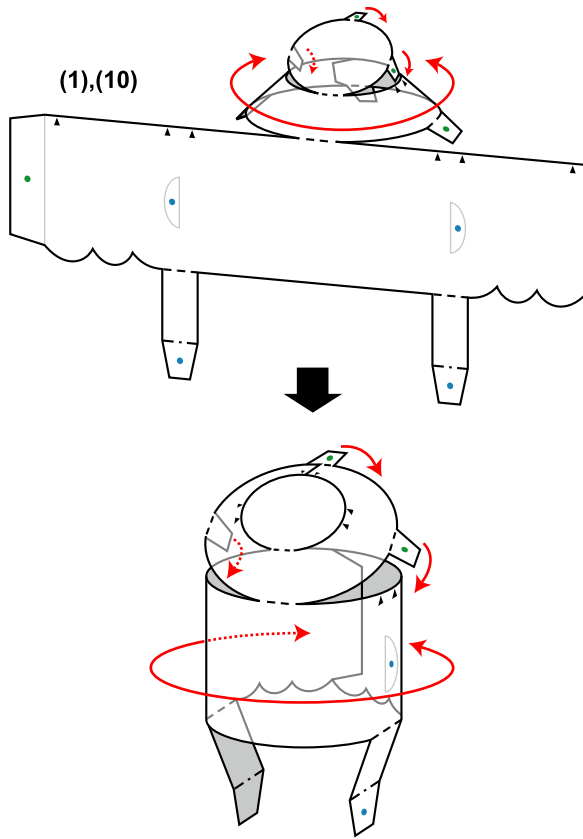

2

(2),(3),(11),(12)

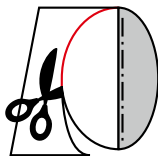
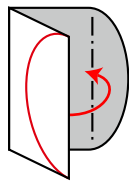

(7),(8),(16),(17)

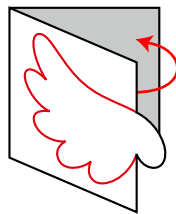

(19-1)

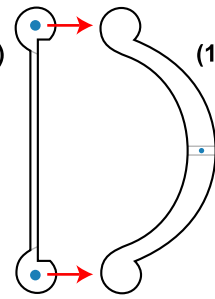

(19-3)

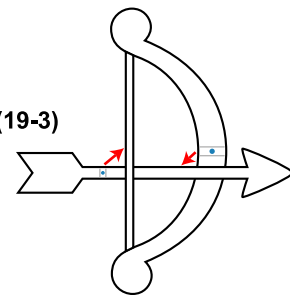



3

